

H-12603

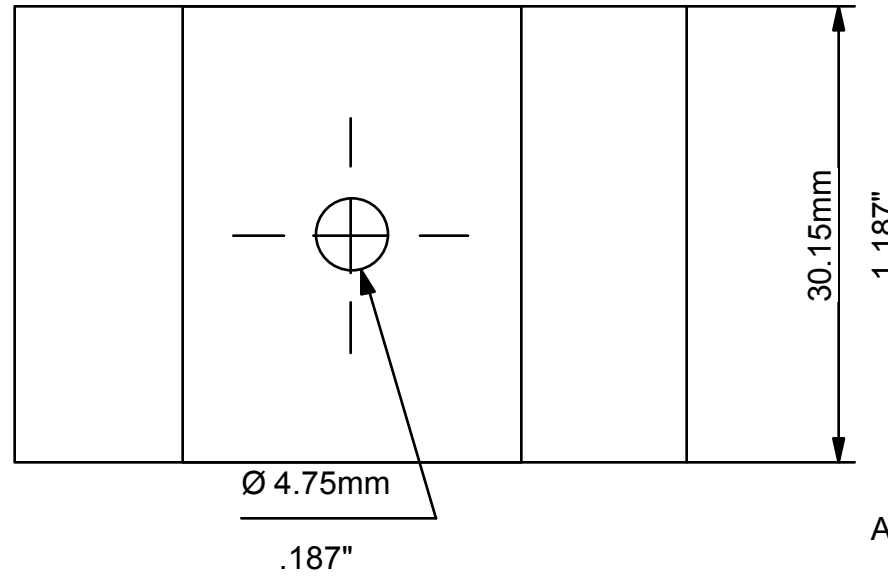
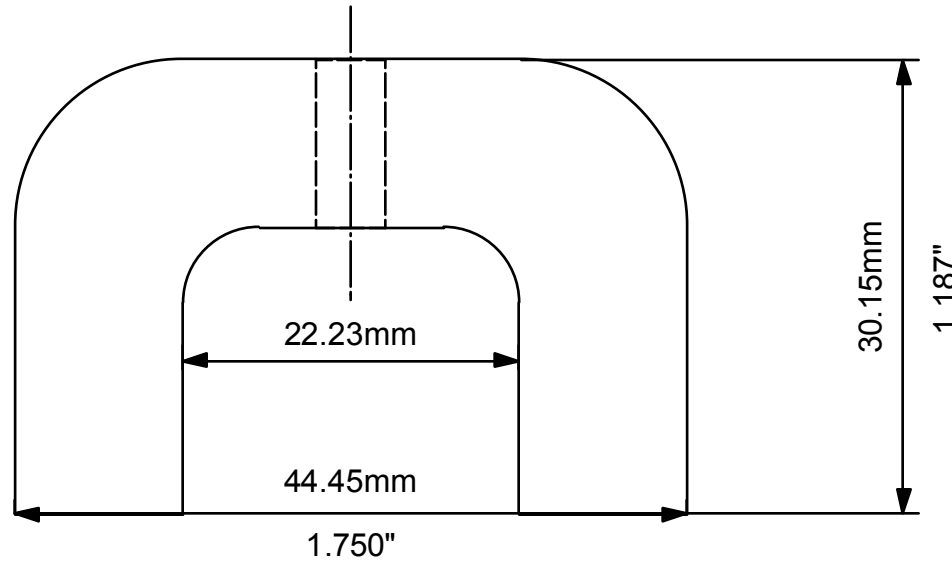

MATERIAL: ALNICO V

AUTOMATIC EQUIPMENT CORP.
E-813
H-12603
05/08/13